

4,3 Kg
Weight

50L
Capacity

746 mm
Height

430 mm
Width



FEATURES

With its smooth flowing lines the 50 litre capacity DIN litter bin has been designed based on the specifications of the DIN standard, and is suitable for any urban setting.

The body and lid are injection moulded in solidcoloured high-density polyethylene stabilised against the combined effects of UV radiation and water, and are also resistant to bad weather, detergents, mould and bacteria.

A mounting system manufactured from galvanised steel complying with standard DIN 30713.

The system facilitates easy installation on streetlamps, posts, walls.

Manufactured using environmentally-friendly recyclable materials.

Its smooth surface prevents build-up of dirt and makes cleaning easier.

Stable colours using pigments that do not contain heavy metals.

Available in a wide range of colours.

STANDARDS

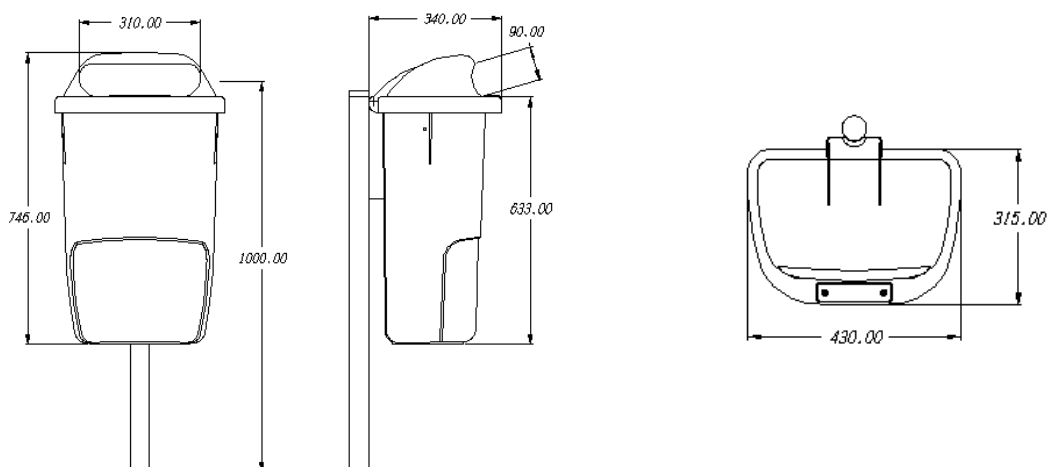

ATTRIBUTES



QUALITY



ERGONOMIC

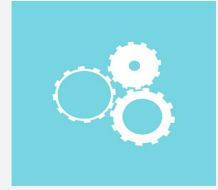

FUNCTIONALITY

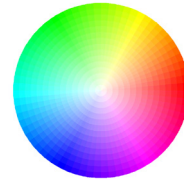

AVAILABLE IN A WIDE RANGE
OF COLOURS

EQUIPMENT

A locking system utilising a standard key is provided to prevent unauthorised use by people other than the maintenance team.

A support made from I.H.A. F-112 steel plate, galvanised to prevent rusting.

Space on the front to display a customised embossed logo or thermal transfer graphic - maximum dimensions 200 x 200 mm.

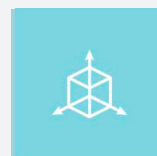

Design



Customised



Easy to clean

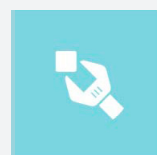

Easier maintenance

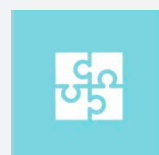

Easier assembled

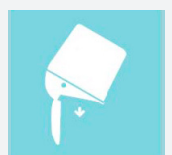

Easier emptying